

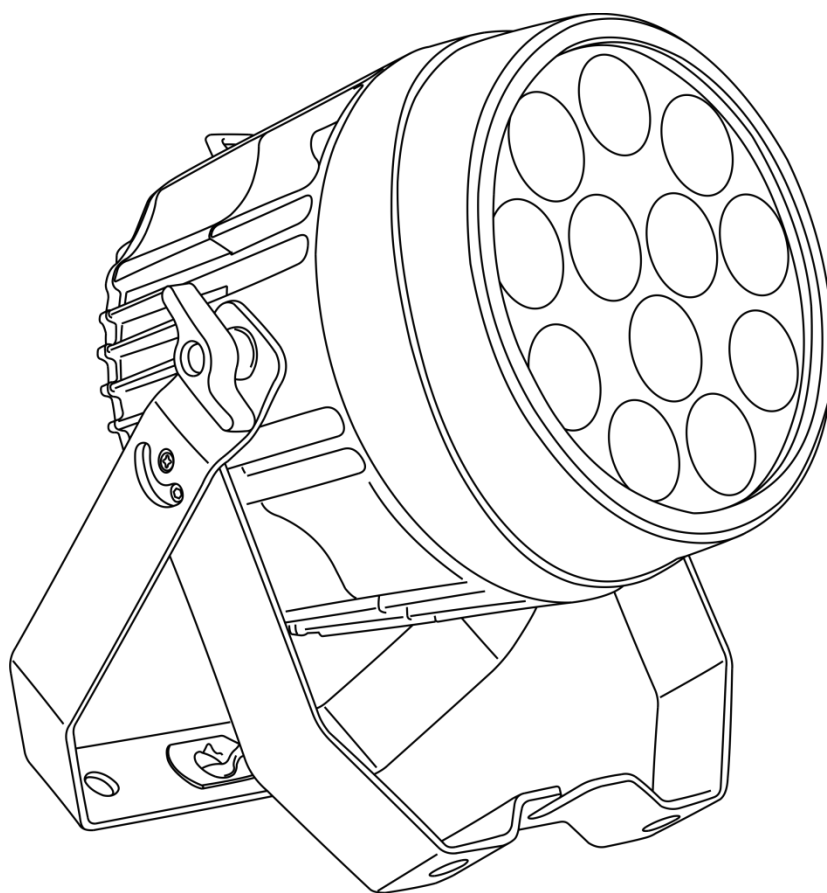

MANUAL



ENGLISH

**NanoQ 12 Q4 V1**

Ordercode: 43710

## Table of contents

<b>Warning</b> .....	2
Safety Instructions .....	2
Operating Determinations .....	4
Rigging .....	4
Connection with the mains.....	5
Return Procedure.....	5
Claims.....	5
<b>Description of the device</b> .....	6
Features .....	6
Frontside.....	6
Backside .....	7
<b>Installation</b> .....	7
<b>Set Up and Operation</b> .....	7
Control Modes.....	8
One NanoQ 12 Q4 (Auto run program, Built-in programs and Sound-controlled mode) .....	8
One NanoQ 12 Q4 (Manual Mode).....	8
Multiple NanoQ 12 Q4s (Master / Slave Control) .....	8
Multiple NanoQ 12 Q4s (DMX Control).....	9
Fixture Linking.....	10
Data Cabling.....	10
Control Panel.....	11
Control Mode .....	11
DMX Addressing.....	11
Menu Overview.....	12
Main Menu Options.....	13
1. Auto run mode .....	13
2. Built-in programs .....	13
3. Manual mode .....	14
3.1. Dimmer settings.....	14
3.2. Zoom settings .....	14
3.3. Backlight dimmer settings.....	14
4. Sound-controlled mode .....	14
5. DMX-512 mode .....	15
6. Master/Slave mode.....	15
7. Settings.....	15
7.1. Display settings.....	15
7.2. Reset settings.....	15
7.3. Dimming curves .....	16
7.4. Dimming mode .....	16
8. System information .....	16
DMX Channels.....	17
6 Channels .....	17
10 Channels .....	17
14 Channels .....	18
<b>Maintenance</b> .....	21
<b>Troubleshooting</b> .....	21
No Light.....	21
No Response to DMX.....	21
<b>Product Specification</b> .....	23
<b>Dimensions</b> .....	24
<b>Notes</b> .....	25

## Warning



**For your own safety, please read this user manual carefully  
before your initial start-up!**



### Unpacking Instructions

Immediately upon receiving this product, carefully unpack the carton and check the contents to ensure that all parts are present, and have been received in good condition. Notify the dealer immediately and retain packing material for inspection if any parts appear damaged from shipping or the carton itself shows signs of mishandling. Save the carton and all packing materials. In the event that a fixture must be returned to the factory, it is important that the fixture be returned in the original factory box and packing.

### Your shipment includes:

- Showtec NanoQ 12 Q4
- Schuko to Pro power connector power cable (1,5 m)
- User manual

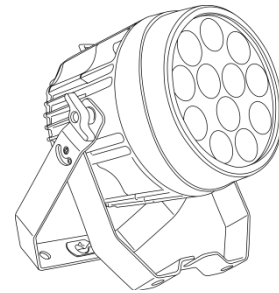

### LED Expected Lifespan

LEDs gradually decline in brightness over time. HEAT is the dominant factor that leads to the acceleration of this decline. Packaged in clusters, LEDs exhibit higher operating temperatures than in ideal or singular optimum conditions. For this reason when all color LEDs are used at their fullest intensity, life of the LEDs is significantly reduced. If improving your lifespan expectancy is of a higher priority, place care in providing for lower operational temperatures. This may include climatic-environmental and the reduction of overall projection intensity.



#### CAUTION!

**Keep this device away from rain and moisture!  
Unplug mains lead before opening the housing!**



### Safety Instructions

Every person involved with the installation, operation and maintenance of this device has to:

- be qualified
- follow the instructions of this manual



**CAUTION! Be careful with your operations.  
With a dangerous voltage you can suffer  
a dangerous electric shock when touching the wires!**



Before your initial start-up, please make sure that there is no damage caused by transportation. Should there be any, consult your dealer and do not use the device.

To maintain perfect condition and to ensure a safe operation, it is absolutely necessary for the user to follow the safety instructions and warning notes written in this manual.

Please consider that damages caused by manual modifications to the device are not subject to warranty.

This device contains no user-serviceable parts. Refer servicing to qualified technicians only.

**IMPORTANT:**

The manufacturer will not accept liability for any resulting damages caused by the non-observance of this manual or any unauthorized modification to the device.

- Never let the power cord come into contact with other cables! Handle the power cord and all connections with the mains with particular caution!
- Never remove warning or informative labels from the unit.
- Never use anything to cover the ground contact.
- Never place any material over the lens.
- Never look directly into the light source.
- Never leave any cables lying around.
- Do not insert objects into air vents.
- Do not connect this device to a dimmerpack.
- Do not switch the device on and off in short intervals, as this would reduce the device's life.
- Do not touch the device's housing bare-handed during its operation. Allow the fixture to cool for at least 5 minutes before handling.
- Do not shake the device. Avoid brute force when installing or operating the device.
- Only use device indoor, avoid contact with water or other liquids.
- Only operate the fixture after having checked that the housing is firmly closed and all screws are tightly fastened.
- Only operate the device after having familiarized with its functions.
- Avoid flames and do not put close to flammable liquids or gases.
- Always keep case closed while operating.
- Always allow free air space of at least 50 cm around the unit for ventilation.
- Always disconnect power from the mains, when device is not used or before cleaning! Only handle the power cord by the plug. Never pull out the plug by tugging the power cord.
- Make sure that the device is not exposed to extreme heat, moisture or dust.
- Make sure that the available voltage is not higher than stated on the rear panel.
- Make sure that the power cord is never crimped or damaged. Check the device and the power cord from time to time.
- If the lens is obviously damaged, it has to be replaced. So that its functions are not impaired, due to cracks or deep scratches.
- If device is dropped or struck, disconnect mains power supply immediately. Have a qualified engineer inspect for safety before operating.
- If the device has been exposed to drastic temperature fluctuation (e.g. after transportation), do not switch it on immediately. The arising condensation water might damage your device. Leave the device switched off until it has reached room temperature.
- If your Showtec device fails to work properly, discontinue use immediately. Pack the unit securely (preferably in the original packing material), and return it to your Showtec dealer for service.
- For adult use only. Device must be installed out of the reach of children. Never leave the unit running unattended.
- Never attempt to bypass the thermostatic switch or fuses.
- For replacement use fuses of same type and rating only.
- The user is responsible for correct positioning and operating of the NanoQ 12 Q4. The manufacturer will not accept liability for damages caused by the misuse or incorrect installation of this device.
- This device falls under protection class I. Therefore it is essential to connect the yellow/green conductor to earth.
- Repairs, servicing and electric connection must be carried out by a qualified technician.
- **WARRANTY:** Till one year after date of purchase.



**CAUTION! Eyedamages!!!**  
**Avoid looking directly into the lightsource!!!**  
**(meant especially for epileptics)!!!**



## Operating Determinations

- This device is not designed for permanent operation. Consistent operation breaks will ensure that the device will serve you for a long time without defects.
- The minimum distance between light-output and the illuminated surface must be more than 1 meter.
- The maximum ambient temperature  $t_a = 40^\circ\text{C}$  must never be exceeded.
- The relative humidity must not exceed 50 % with an ambient temperature of  $40^\circ\text{C}$ .
- If this device is operated in any other way, than the one described in this manual, the product may suffer damages and the warranty becomes void.
- Any other operation may lead to dangers like short-circuit, burns, electric shock, crash etc.

You endanger your own safety and the safety of others!

## Rigging

Please follow the European and national guidelines concerning rigging, trussing and all other safety issues.

Do not attempt the installation yourself!

Always let the installation be carried out by an authorized dealer!

## Procedure:

- If the NanoQ 12 Q4 is lowered from the ceiling or high joists, professional trussing systems have to be used.
- Use a clamp to mount the NanoQ 12 Q4, with the mounting-bracket, to the trussing system.
- The NanoQ 12 Q4 must never be fixed swinging freely in the room.
- The installation must always be secured with a safety attachment, e.g. an appropriate safety net or safety-cable.
- When rigging, derigging or servicing the projector, always make sure, that the area below the installation place is blocked and staying in the area is forbidden.

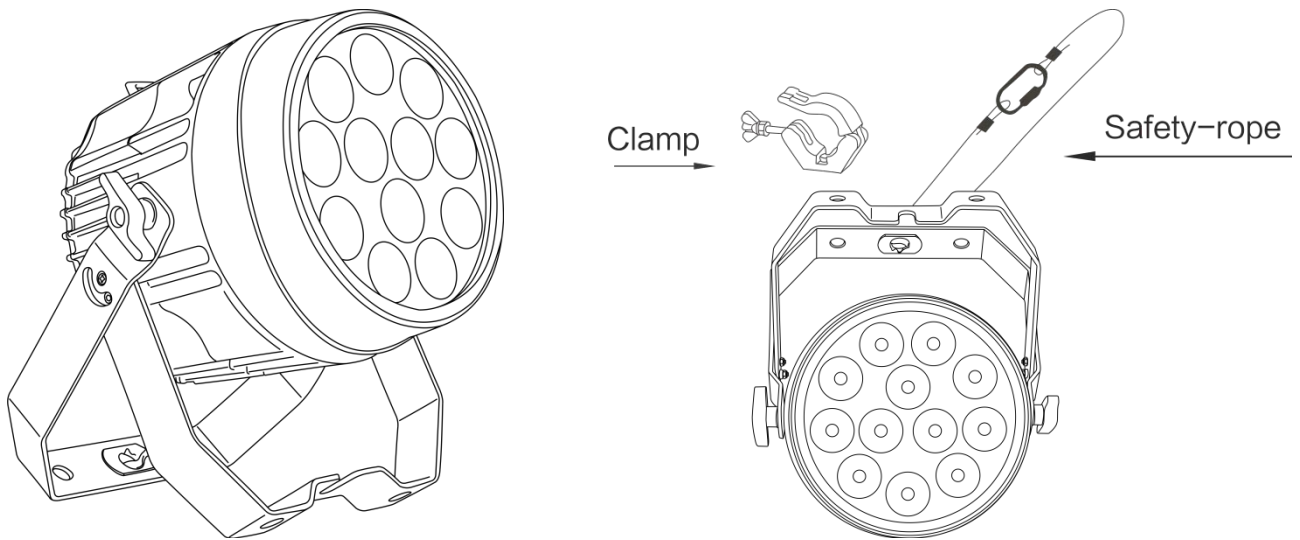

Improper installation can cause serious damage to people and property!

**Connection with the mains**

Connect the device to the mains with the power-plug.

Always pay attention, that the right color cable is connected to the right place.

International	EU Cable	UK Cable	US Cable	Pin
L	BROWN	RED	YELLOW/COPPER	PHASE
N	BLUE	BLACK	SILVER	NEUTRAL
	YELLOW/GREEN	GREEN	GREEN	PROTECTIVE GROUND

Make sure that the device is always connected properly to the earth!

**Improper installation can cause serious damage to people and property!**



**⚠ Return Procedure ⚠**

Returned merchandise must be sent prepaid and in the original packing, call tags will not be issued. Package must be clearly labeled with a Return Authorization Number (RMA number). Products returned without an RMA number will be refused. Highlite will not accept the returned goods or any responsibility. Call Highlite 0031-455667723 or mail [aftersales@highlite.nl](mailto:aftersales@highlite.nl) and request an RMA prior to shipping the fixture. Be prepared to provide the model number, serial number and a brief description of the cause for the return. Be sure to properly pack fixture, any shipping damage resulting from inadequate packaging is the customer's responsibility. Highlite reserves the right to use its own discretion to repair or replace product(s). As a suggestion, proper UPS packing or double-boxing is always a safe method to use.

**Note: If you are given an RMA number, please include the following information on a piece of paper inside the box:**

- 01) Your name.
- 02) Your address.
- 03) Your phone number.
- 04) A brief description of the symptoms.

**Claims**

The client has the obligation to check the delivered goods immediately upon delivery for any shortcomings and/or visible defects, or perform this check after our announcement that the goods are at their disposal. Damage incurred in shipping is the responsibility of the shipper; therefore the damage must be reported to the carrier upon receipt of merchandise.

It is the customer's responsibility to notify and submit claims with the shipper in the event that a fixture is damaged due to shipping. Transportation damage has to be reported to us within one day after receipt of the delivery.

Any return shipment has to be made post-paid at all times. Return shipments must be accompanied with a letter defining the reason for return shipment. Non-prepaid return shipments will be refused, unless otherwise agreed in writing.

Complaints against us must be made known in writing or by fax within 10 working days after receipt of the invoice. After this period complaints will not be handled anymore.

Complaints will only then be considered if the client has so far complied with all parts of the agreement, regardless of the agreement of which the obligation is resulting.

## Description of the device

---

### Features

The Showtec NanoQ 12 Q4 is a high power parcan with zoom function.

- Input Voltage: 100-240 VAC, 60/50Hz
- Power consumption: 150W
- Light output @ 2 m: 14300 lux
- LED Quantity: 12 x 4-in-1 10W RGBW LEDs
- Backlight: 21 x 3-in-1 RGB LEDs
- DMX modes: 6, 10, 14 channels
- Beam angle: 5-60°
- Color mixing: RGBW
- Color range: 16,7 million additive colors
- IP Rating: IP20
- DMX-control via standard DMX-controller
- Onboard: LCD display for easy setup
- Control mode: Auto run, Built-in programs, Manual mode, Sound-controlled, Master/Slave, DMX512
- Dimmer: 0-100%
- Strobe: 0-20Hz
- Housing: Die-cast aluminum powder coat finish
- Power connector: Pro power connector
- Data connectors: 3-pin/5-pin XLR IN, 3-pin/5-pin XLR OUT
- Cooling: Convection (no fans) which eliminates the use of fans and noise
- Dimensions: 215 x 185 x 290 mm (LxWxH)
- Weight: 4,4 kg

### Optional accessories:

**D7246** – Case for NanoQ 12 Q4

**43711** – Top hat for NanoQ 12 Q4

### Frontside

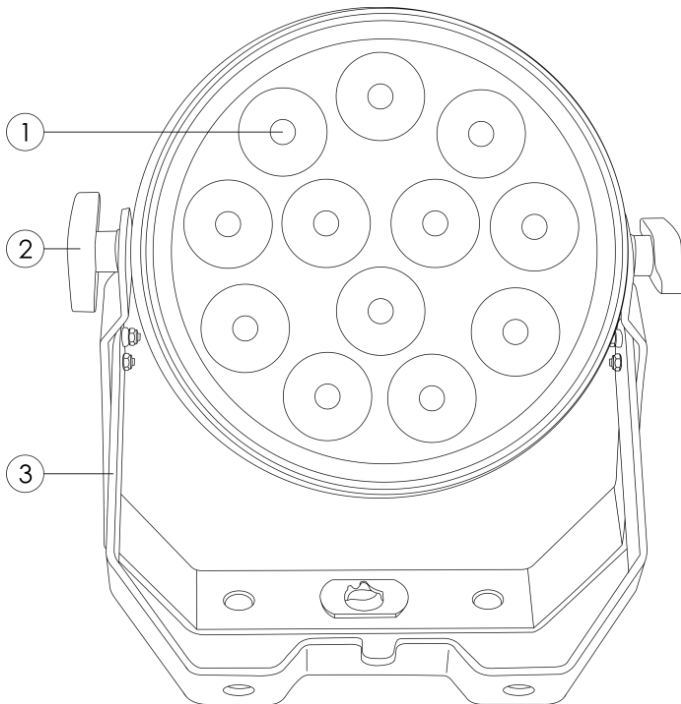

Fig. 01

- 01) 12 x 4-in-1 10W RGBW LEDs
- 02) Adjustment screw
- 03) Mounting bracket with inclination screw



## Backside

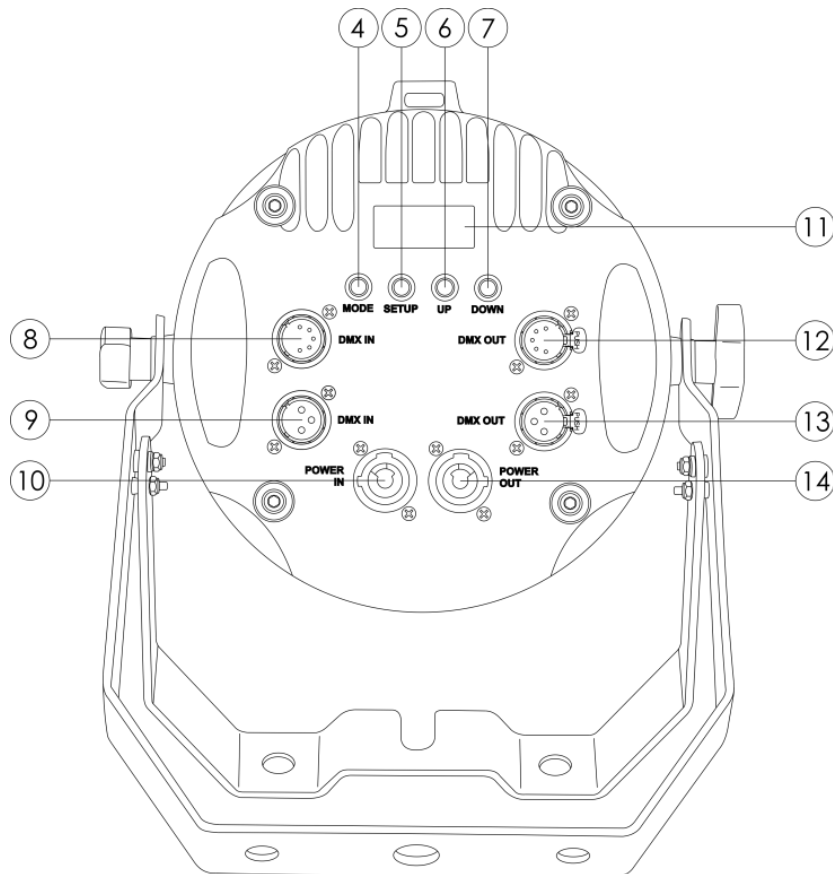

Fig. 02

- 04) Mode button
- 05) Setup button
- 06) Up button
- 07) Down button
- 08) 5-pin DMX signal connector IN
- 09) 3-pin DMX signal connector IN
- 10) Pro power connector 100-240V IN
- 11) LCD display
- 12) 5-pin DMX signal connector OUT
- 13) 3-pin DMX signal connector OUT
- 14) Pro power connector 100-240V OUT

NOTE: Knowledge of DMX is required to fully utilize this unit.

## Installation

Remove all packing materials from the NanoQ 12 Q4. Check that all foam and plastic padding is removed. Connect all cables.

**Do not supply power before the whole system is set up and connected properly.**

**Always disconnect from electric mains power supply before cleaning or servicing.**

**Damages caused by non-observance are not subject to warranty.**

## Set Up and Operation

Follow the directions below, as they pertain to your preferred operation mode.

Before plugging the unit in, always make sure that the power supply matches the product specification voltage. Do not attempt to operate a 120V specification product on 230V power, or vice versa.



## Control Modes

There are 6 modes:

- Auto run program
- Built-in programs
- Manual mode
- Sound-controlled mode
- Master / Slave
- DMX-512 (6CH, 10CH or 14CH)

### One NanoQ 12 Q4 (Auto run program, Built-in programs and Sound-controlled mode)

- 01) Fasten the effect light onto firm trussing. Leave at least 0,5 meter on all sides for air circulation.
- 02) Always use a safety cable (ordercode 70140 / 70141).
- 03) Plug the end of the electric mains power cord into a proper electric power supply socket.
- 04) When the NanoQ 12 Q4 is not connected with a DMX cable, it functions as a stand-alone device.
- 05) Please see page 13-14 for more information.

### One NanoQ 12 Q4 (Manual Mode)

- 01) Fasten the effect light onto firm trussing. Leave at least 0,5 meter on all sides for air circulation.
- 02) Always use a safety cable (ordercode 70140 / 70141).
- 03) Plug the end of the electric mains power cord into a proper electric power supply socket.
- 04) When the NanoQ 12 Q4 is not connected with a DMX-cable, it functions as a stand-alone device.
- 05) Please see page 14 for more information about the manual mode functions.

### Multiple NanoQ 12 Q4s (Master / Slave Control)

- 01) Fasten the effect light onto firm trussing. Leave at least 0,5 meter on all sides for air circulation.
- 02) Always use a safety cable (ordercode 70140 / 70141).
- 03) Plug the end of the electric mains power cord into a proper electric power supply socket.
- 04) Use a 3-pin XLR cable to connect the NanoQ 12 Q4s.

The pins:



- 01) Earth
- 02) Signal (-)
- 03) Signal (+)

- 05) Link the units as shown in (fig.03). Connect a DMX signal cable from the first unit's DMX "out" socket to the second unit's "in" socket. Repeat this process to link the second, third, and fourth units. This means that you can set your desired operation mode on the master device and all slave devices will react the same as the master device.

### Multiple NanoQ 12 Q4s (Master / Slave Set Up)

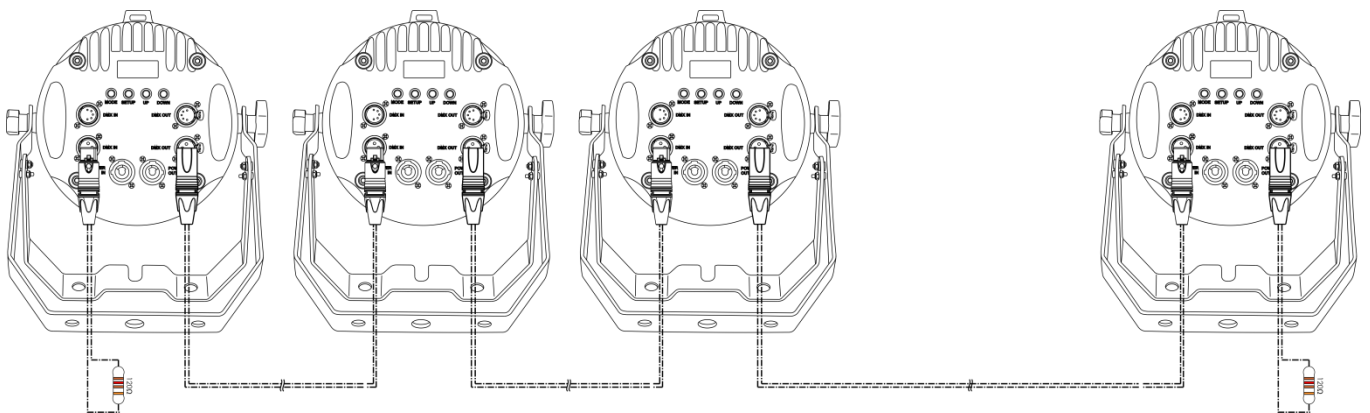
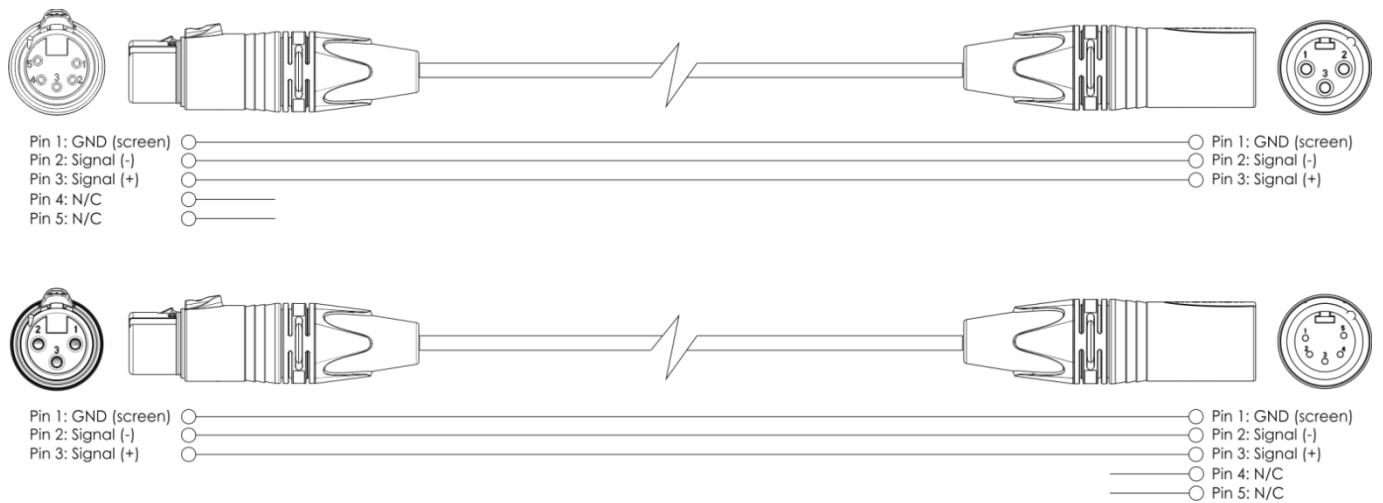

Fig. 03

## Multiple NanoQ 12 Q4s (DMX Control)

- 01) Fasten the effect light onto firm trussing. Leave at least 0,5 meter on all sides for air circulation.
- 02) Always use a safety cable (ordercode 70140 / 70141).
- 03) Plug the end of the electric mains power cord into a proper electric power supply socket.
- 04) Use a 3-pin/5-pin XLR cable to connect the NanoQ 12 Q4 and other devices.



- 05) Link the units as shown in (fig.04). Connect a DMX signal cable from the first unit's DMX "out" socket to the second unit's "in" socket. Repeat this process to link the second, third, and fourth units.
- 06) Supply electric power: Plug electric mains power cords into each unit's Pro power connector socket, then plug the other end of the mains power cord into proper electric power supply sockets, starting with the first unit. Do not supply power before the whole system is set up and connected properly.

## Multiple NanoQ 12 Q4s (DMX Set Up)

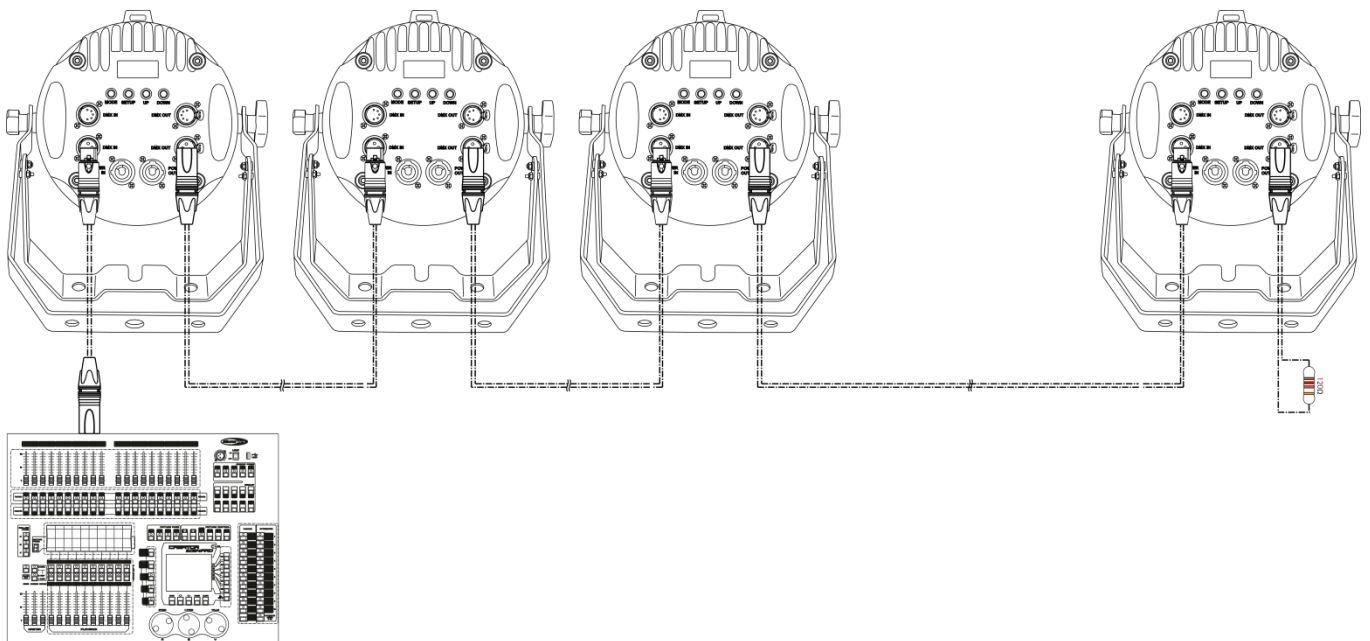



Fig. 04

## Fixture Linking

You will need a serial data link to run light shows of one or more fixtures using a DMX-512 controller or to run synchronized shows on two or more fixtures set to a master / slave operating mode. The combined number of channels required by all the fixtures on a serial data link determines the number of fixtures the data link can support.

**Important:** Fixtures on a serial data link must be daisy chained in one single line. To comply with the EIA-485 standard no more than 30 devices should be connected on one data link. Connecting more than 30 fixtures on one serial data link without the use of a DMX optically isolated splitter may result in deterioration of the digital DMX signal.

 Maximum recommended DMX data link distance: 100 meters  
 Maximum recommended number of NanoQ 12 Q4s on a DMX data link: 30 fixtures  
 Maximum recommended number of NanoQ 12 Q4s on a power link: 4 fixtures @110V  
 Maximum recommended number of NanoQ 12 Q4s on a power link: 8 fixtures @240V

## Data Cabling

To link fixtures together you must obtain data cables. You can purchase DAP Audio certified DMX cables directly from a dealer/distributor or construct your own cable. If you choose to create your own cable please use data-grade cables that can carry a high quality signal and are less prone to electromagnetic interference.

### DAP Audio DMX Data Cables

- DAP Audio Basic microphone cable for allround use. bal. XLR/M 3-pin > XLR/F 3-pin. **Ordercode** FL01150 (1,5 m), FL013 (3 m), FL016 (6 m), FL0110 (10 m), FL0115 (15 m), FL0120 (20 m).
- DAP Audio X-type data cable XLR/M 3-pin > XLR/F 3-pin. **Ordercode** FLX0175 (0,75 m), FLX01150 (1,5 m), FLX013 (3 m), FLX016 (6 m), FLX0110 (10 m).
- DAP Audio cable for the demanding user with exceptional audio-qualities and connector made by Neutrik®. **Ordercode** FL71150 (1,5 m), FL713 (3 m), FL716 (6 m), FL7110 (10 m).
- DAP Audio cable for the demanding user with exceptional audio-qualities and connector made by Neutrik®. **Ordercode** FL7275 (0,75 m), FL72150 (1,5 m), FL723 (3 m), FL726 (6 m), FL7210 (10 m).
- DAP Audio 110 Ohm cable with digital signal transmission. **Ordercode** FL0975 (0,75 m), FL09150 (1,5 m), FL093 (3 m), FL096 (6 m), FL0910 (10 m), FL0915 (15 m), FL0920 (20 m).

The NanoQ 12 Q4 can be operated with a controller in **control mode** or without the controller in **stand-alone mode**.

## Control Panel

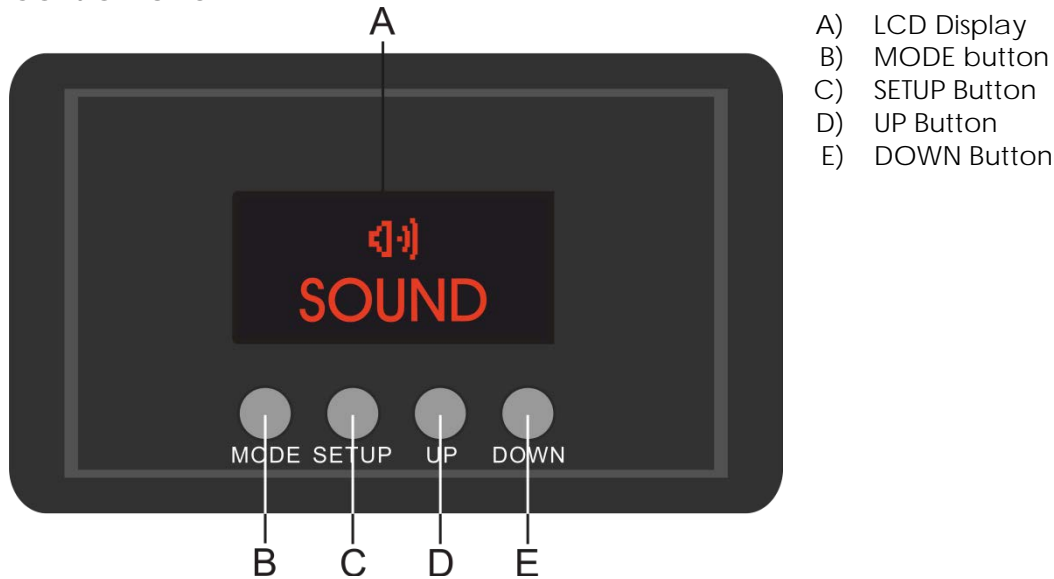

Fig. 05

## Control Mode

The fixtures are individually addressed on a data-link and connected to the controller. The fixtures respond to the DMX signal from the controller.

## DMX Addressing

The control panel on the front side of the base allows you to assign the DMX fixture address, which is the first channel from which the NanoQ 12 Q4 will respond to the controller.

Please note when you use the controller, the unit has **14** channels.

When using multiple NanoQ 12 Q4s make sure you set the DMX addresses right.

Therefore, the DMX address of the first NanoQ 12 Q4 should be **1(001)**; the DMX address of the second NanoQ 12 Q4 should be **1+14=15 (015)**; the DMX address of the third NanoQ 12 Q4 should be **15+14=29 (029)**, etc.

Please, be sure that you do not have any overlapping channels in order to control each NanoQ 12 Q4 correctly.

If two or more NanoQ 12 Q4s are addressed similarly, they will work similarly.

## Controlling:

After having addressed all NanoQ 12 Q4 fixtures, you may now start operating these via your lighting controller.

**Note:** After switching on, the NanoQ 12 Q4 will automatically detect whether DMX 512 data is received or not. If there is no data received at the DMX-input, the display text on the control panel will not flash.

The problem may be:

- The XLR cable from the controller is not connected with the input of the NanoQ 12 Q4.
- The controller is switched off or defective, the cable or connector is defective, or the signal wires are swapped in the input connector.

**Note:** It's necessary to insert a XLR termination plug (with 120 Ohm) in the last fixture in order to ensure proper transmission on the DMX data link.

## Display Off after 30 seconds

When no button is pressed for 30 seconds, the display will turn off.







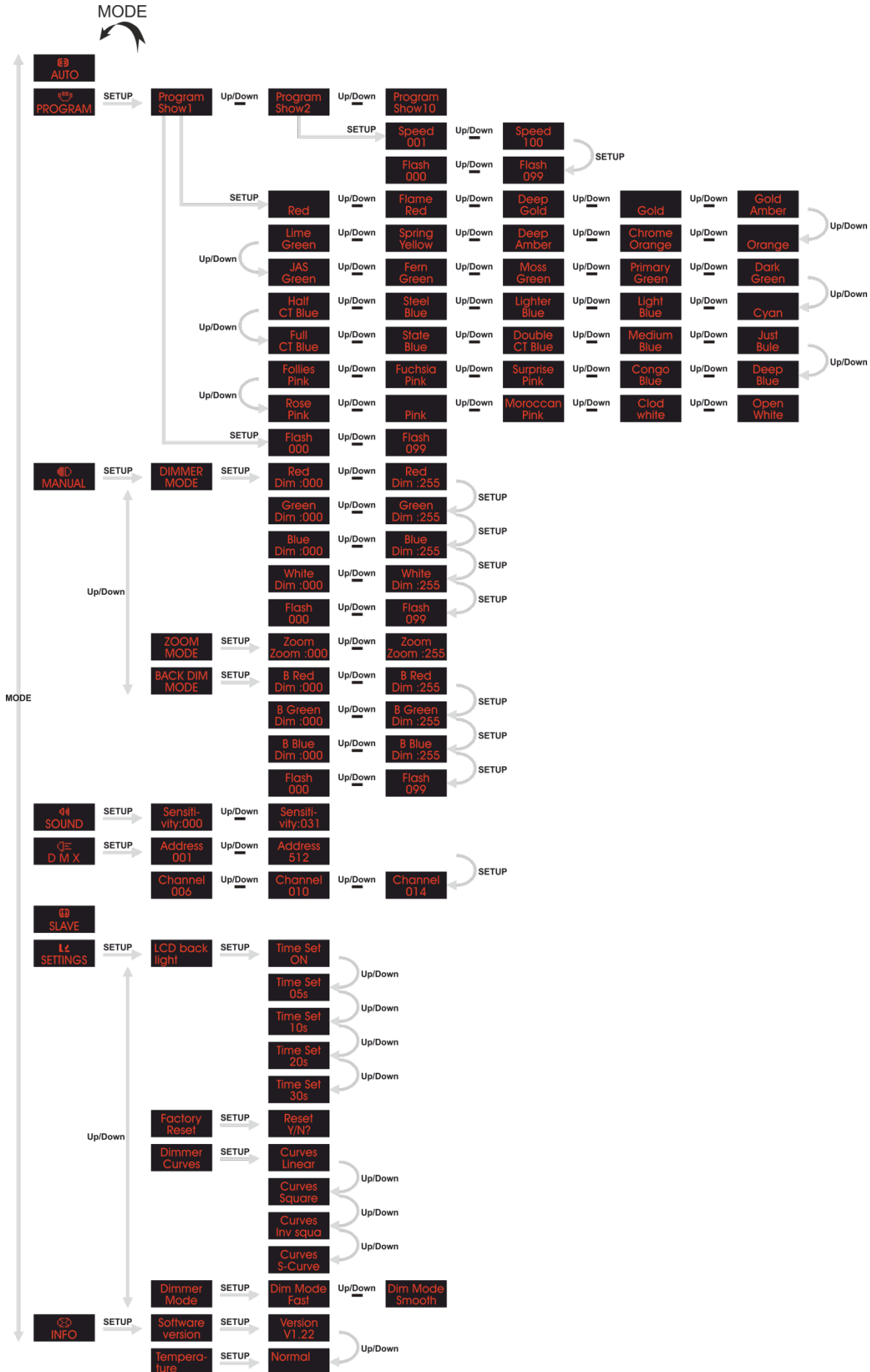

To light up the display, you have to press the MODE, SETUP, UP or DOWN button.

Once you have pressed the button, the display will light up.

# Menu Overview



## Main Menu Options

-  AUTO Auto run mode
-  PROGRAM Built-in programs
-  MANUAL Manual mode
-  SOUND Sound-controlled mode
-  DMX DMX-512 mode
-  SLAVE Master/Slave mode
-  SETTINGS Settings
-  INFO System information



### 1. Auto run mode

With this menu you can activate the auto run program.

- 01) Press the **MODE** button until the display shows .
- 02) The device will now run all the built-in programs in a sequence.

### 2. Built-in programs

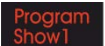
With this menu you can you can set the built-in programs.

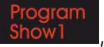
- 01) Press the **MODE** button until the display shows .
- 02) Press the **SETUP** button to open the menu.
- 03) Press the **UP/DOWN** buttons to select one of the 10 built-in programs:  Up/Down .
- 04) When the display shows , press the **SETUP** button to open the submenu.
- 05) Press the **UP/DOWN** buttons to choose one of the following 35 color presets:



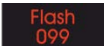

- 06) Press the **SETUP** button again, to proceed to strobe flash frequency settings.
- 07) Press the **UP/DOWN** buttons to increase/decrease the strobe flash frequency. The adjustment range is between  Up/Down , from OFF to high frequency.





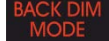

## 3. Manual mode

With this menu you can set the device's static colors.

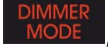

- 01) Press the **MODE** button until the display shows .
- 02) Press the **SETUP** button to open the menu.
- 03) Press the **UP/DOWN** buttons to choose one of the 3 options:

	Dimmer settings
	Zoom settings
	Backlight dimmer settings



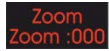

### 3.1. Dimmer settings

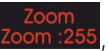
- 01) When the display shows , press the **SETUP** button to open the menu.
- 02) Repeatedly press the **SETUP** button to toggle between the static colors (Red, Green, Blue, White) and strobe.
- 03) Once you have chosen the desired color, press the **UP/DOWN** buttons to increase/decrease the LED intensity. The adjustment range is between 0-255, from OFF to full ON.
- 04) You can combine Red, Green, Blue and White to create an infinite range of colors (0-255).
- 05) Press the **SETUP** button again to proceed to strobe flash frequency settings.
- 06) Press the **UP/DOWN** buttons to increase/decrease the strobe flash frequency. The adjustment range is between   , from OFF to high frequency.

### 3.2. Zoom settings





- 01) When the display shows , press the **SETUP** button to open the menu.
- 02) Press the **UP/DOWN** buttons to increase/decrease the zoom factor. The adjustment range is between   , from OFF to full zoom.

### 3.3. Backlight dimmer settings

- 01) When the display shows , press the **SETUP** button to open the menu.
- 02) Repeatedly press the **SETUP** button to toggle between the secondary colors (Red, Green, Blue) and strobe.
- 03) Once you have chosen the desired color, press the **UP/DOWN** buttons to increase/decrease the LED intensity. The adjustment range is between 0-255, from OFF to full ON.
- 04) You can combine Red, Green, Blue and White to create an infinite range of colors (0-255).
- 05) Press the **SETUP** button again to proceed to strobe flash frequency settings.
- 06) Press the **UP/DOWN** buttons to increase/decrease the strobe flash frequency. The adjustment range is between   , from OFF to high frequency.

## 4. Sound-controlled mode







With this menu you can set the sound-controlled mode.

- 01) Press the **MODE** button until the display shows .
- 02) Press the **SETUP** button to open the menu.
- 03) Press the **UP/DOWN** buttons to increase/decrease the sound sensitivity. The adjustment range is between   , from OFF to high sound sensitivity.
- 04) The device will now react to the beat of the background music.

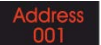

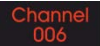
### 5. DMX-512 mode

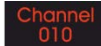
With this menu you can adjust the device's DMX settings.

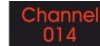
- 01) Press the **MODE** button until the display shows .
- 02) Press the **SETUP** button to open the menu.
- 03) Press the **UP/DOWN** buttons to set the device's DMX starting address. The adjustment range is between   .
- 04) Press the **SETUP** button to proceed to DMX channel mode settings.
- 05) Press the **UP/DOWN** buttons to choose one of the 3 DMX channel modes:     .

### 6. Master/Slave mode





With this menu you can set the device as a slave.

- 01) Press the **MODE** button until the display shows .
- 02) The device is now set as a slave and will react the same as the master device.

### 7. Settings

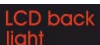
With this menu you can adjust the device's settings.



- 01) Press the **MODE** button until the display shows .
- 02) Press the **SETUP** button to open the menu.
- 03) Press the **UP/DOWN** buttons to choose one of the 3 options:
 

	Display settings
	Reset settings
	Dimming curves
	Dimming mode

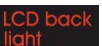
#### 7.1. Display settings

- 01) When the display shows , press the **SETUP** button to open the submenu.
- 02) Press the **UP/DOWN** buttons to toggle between the following 5 options:
  - ON
  - 05 seconds
  - 10 seconds
  - 20 seconds
  - 30 seconds
- 03) This menu determines the time after which the display will turn OFF, if no button is pressed.

#### 7.2. Reset settings

- 01) When the display shows , press the **SETUP** button to open the submenu. The display will show .
- 02) Press the **SETUP** button (to reset the settings) or the **MODE** button (to return to the main menu).

7.3. Dimming curves

- 01) When the display shows **Dimmer Curves**, press the **SETUP** button to open the submenu.
- 02) Press the **UP/DOWN** buttons to choose one of the 4 dimming curves: Linear, Square, Inverted square and S-curve:

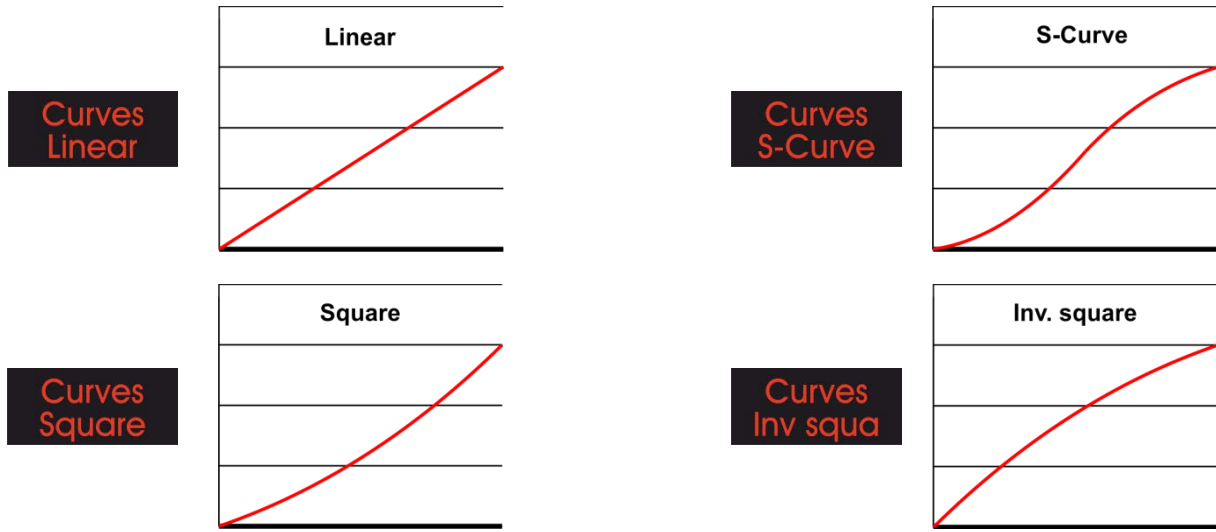

7.4. Dimming mode

- 01) When the display shows **Dimmer Mode**, press the **SETUP** button to open the submenu.
- 02) Press the **UP/DOWN** buttons to choose either Fast or Smooth dimming mode.

8. System information

With this menu you can monitor the most important information on the device.

- 01) Press the **MODE** button until the display shows **INFO**.
- 02) Press the **SETUP** button to open the submenu.
- 03) Press the **UP/DOWN** buttons to toggle between the 2 options:

**Software version**                      Device's software version

**Temperature**                              Motor temperature

- 04) Press the **SETUP** button to see either the current software version or the motor temperature.

## DMX Channels

### 6 Channels

#### Channel 1 – Dimmer

0-255 From black to brightest

#### Channel 2 – Red Dimmer intensity Dimmer must be open

0-255 Red from 0 – 100%

#### Channel 3 – Green Dimmer intensity Dimmer must be open

0-255 Green from 0 – 100%

#### Channel 4 – Blue Dimmer intensity Dimmer must be open

0-255 Blue from 0 – 100%

#### Channel 5 – White Dimmer intensity Dimmer must be open

0-255 White from 0 – 100%

#### Channel 6 – Zoom

0-255 Zoom from 0 - 100%

### 10 Channels

#### Channel 1 – Dimmer

0-255 From black to brightest

#### Channel 2 – Red Dimmer intensity Dimmer must be open

0-255 Red from 0 – 100%

#### Channel 3 – Green Dimmer intensity Dimmer must be open

0-255 Green from 0 – 100%

#### Channel 4 – Blue Dimmer intensity Dimmer must be open

0-255 Blue from 0 – 100%

#### Channel 5 – White Dimmer intensity Dimmer must be open

0-255 White from 0 - 100%

#### Channel 6 – Strobe Dimmer and CH2-5 must be open

0-15 No function

16-255 Strobe effect, from slow to fast (0-20Hz)

#### Channel 7 – Zoom

0-255 Zoom from 0 - 100%

#### Channel 8 – Backlight Dimmer must be open

0-255 Red from 0 – 100%

**Channel 9 – Backlight**  **Dimmer must be open** 

0-255 Green from 0 – 100%

**Channel 10 – Backlight**  **Dimmer must be open** 

0-255 Blue from 0 – 100%

**14 Channels**

**Channel 1 – Dimmer**

0-255 From black to brightest

**Channel 2 – LEE Colors**  **Dimmer must be open** 

0-10 Dimming effect function

11-17 Red

18-24 Flame Red

25-31 Deep Gold Amber

32-38 Millenium Gold

39-45 Gold Amber

46-52 Orange

53-59 Chrome Orange

60-66 Deep Amber

67-73 Spring Yellow

74-80 Lime Green

81-87 JAS Green

88-94 Fern Green

95-101 Moss Green

102-108 Primary Green

109-115 Green

116-122 Medium Blue Green

123-129 Light Blue

130-136 Lighter Blue

137-143 Steel Blue

144-150 Half CT Blue

151-157 Full CT Blue

158-164 State Blue

165-171 Double CT Blue

172-178 Medium Blue

179-185 Just Blue

186-192 Blue

193-199 Congo Blue

200-206 Surprise Pink

207-213 Fuchsia Pink

214-220 Follies Pink

221-227 Special Rose Pink

228-234 Pink

235-241 Moroccan Pink

242-248 Cold White

249-255 Open White

**Channel 3 – Red Dimmer intensity**  **CH2 must be set between 0-10** 

0-255 Red from 0 – 100%

**Channel 4 – Green Dimmer intensity** ⚠️ CH2 must be set between 0-10 ⚠️  
 0-255 Green from 0 – 100%

**Channel 5 – Blue Dimmer intensity** ⚠️ CH2 must be set between 0-10 ⚠️  
 0-255 Blue from 0 – 100%

**Channel 6 – White Dimmer intensity** ⚠️ CH2 must be set between 0-10 ⚠️  
 0-255 White from 0 – 100%

**Channel 7 – Strobe** ⚠️ Dimmer and CH2-6 must be open ⚠️  
 0-15 No function  
 16-255 Strobe effect, from slow to fast (0-20Hz)

**Channel 8 – Zoom**  
 0-255 Zoom from 0 - 100%

**Channel 9 – Backlight Dimmer**  
 0-255 From black to brightest

**Channel 10 – LEE Colors** ⚠️ CH9 must be open ⚠️

0-10 Backlight dimming function

11-17 Red

18-24 Flame Red

25-31 Deep Golden Amber

32-38 Millenium Gold

39-45 Gold Amber

46-52 Orange

53-59 Chrome Orange

60-66 Deep Amber

67-73 Spring Yellow

74-80 Lime Green

81-87 JAS Green

88-94 Fern Green

95-101 Moss Green

102-108 Primary Green

109-115 Green

116-122 Medium Blue Green

123-129 Light Blue

130-136 Lighter Blue

137-143 Steel Blue

144-150 Half CT Blue

151-157 Full CT Blue

158-164 State Blue

165-171 Double CT Blue

172-178 Medium Blue

179-185 Just Blue

186-192 Blue

193-199 Congo Blue

200-206 Surprise Pink

207-213 Fuchsia Pink

214-220 Follies Pink

221-227 Special Rose Pink

228-234 Pink

235-241 Moroccan Pink



---

242-248	Cold White
249-255	Open White



---

**Channel 11 - Backlight**  CH9 must be open and CH10 must be set between 0-10   
0-255 Red from 0 – 100%



---

**Channel 12 - Backlight**  CH9 must be open and CH10 must be set between 0-10   
0-255 Green from 0 – 100%

---

**Channel 13 - Backlight**  CH9 must be open and CH10 must be set between 0-10   
0-255 Blue from 0 – 100%

---

**Channel 14 - Strobe**  CH9, CH11, CH12, CH13 must be open. CH10 must be set between 0-10   
0-15 No function  
16-255 Strobe effect, from slow to fast (0-20Hz)

---

## Maintenance

---

The Showtec NanoQ 12 Q4 requires almost no maintenance. However, you should keep the unit clean. Otherwise, the fixture's light-output will be significantly reduced. Disconnect the mains power supply and then wipe the cover with a damp cloth. Wipe the front glass panel clean with glass cleaner and a soft cloth. Do not use alcohol or solvents. The front glass panel will require weekly cleaning, as smoke-fluid tends to build up residues, reducing the light output very quickly. Do not immerse in liquid. Keep connections clean. Disconnect electric power, and then wipe the DMX and audio connections with a damp cloth. Make sure connections are thoroughly dry before linking equipment or supplying electric power.

The operator has to make sure that safety-relating and machine-technical installations are to be inspected by an expert after every year in the course of an acceptance test.

The operator has to make sure that safety-relating and machine-technical installations are to be inspected by a skilled person once a year.

The following points have to be considered during the inspection:

- 01) All screws used for installing the device or parts of the device have to be tightly connected and must not be corroded.
- 02) There may not be any deformations on housings, fixations and installation spots.
- 03) Mechanically moving parts like axles, eyes and others may not show any traces of wearing.
- 04) The electric power supply cables must not show any damages or material fatigue.

## Troubleshooting

---

### No Light

This troubleshooting guide is meant to help solve simple problems.

If a problem occurs, carry out the steps below in sequence until a solution is found. Once the unit operates properly, do not carry out following steps.

If the light effect does not operate properly, refer servicing to a technician.

Suspect two potential problem areas as: the power supply and the LEDs.

- 01) Power supply. Check if the unit is plugged into an appropriate power supply.
- 02) The LEDs. Return the NanoQ 12 Q4 to your Showtec dealer.
- 03) If both of the above appear to be O.K., plug the unit in again.
- 04) If you are unable to determine the cause of the problem, do not open the NanoQ 12 Q4, as this may damage the unit and the warranty will become void.
- 05) Return the device to your Showtec dealer.

### No Response to DMX

Suspect the DMX cable or connectors, a controller malfunction, a light effect DMX card malfunction.

- 01) Check the DMX setting. Make sure that DMX addresses are correct.
- 02) Check the DMX cable: Unplug the unit; change the DMX cable; then reconnect to electrical power. Try your DMX control again.
- 03) Determine whether the controller or light effect is at fault. Does the controller operate properly with other DMX products? If not, take the controller in for repair. If so, take the DMX cable and the light effect to a qualified technician.



Problem	Probable cause(s)	Solution
One or more fixtures do not function at all.	No power to the fixture.	<ul style="list-style-type: none"> <li>• Check that power is switched on and cables are plugged in.</li> </ul>
	Internal fuse blown.	<ul style="list-style-type: none"> <li>• Return the device to your Showtec dealer</li> </ul>
Fixtures reset correctly, but all respond erratically or not at all to the controller.	The controller is not connected.	<ul style="list-style-type: none"> <li>• Connect controller.</li> </ul>
	3-pin/5-pin XLR Out of the controller does not match XLR Out of the first fixture on the link (i.e. signal is reversed).	<ul style="list-style-type: none"> <li>• Install a phase reversing cable between the controller and the first fixture on the link.</li> </ul>
Fixtures reset correctly, but some respond erratically or not at all to the controller.	Poor data quality	<ul style="list-style-type: none"> <li>• Check data quality. If much lower than 100 percent, the problem may be a bad data link connection, poor quality or broken cables, missing termination plug, or a defective fixture disturbing the link.</li> </ul>
	Bad data link connection	<ul style="list-style-type: none"> <li>• Inspect connections and cables. Correct poor connections. Repair or replace damaged cables.</li> </ul>
	Data link not terminated with 120 Ohm termination plug.	<ul style="list-style-type: none"> <li>• Insert termination plug in output jack of the last fixture on the link.</li> </ul>
	Incorrect addressing of the fixtures.	<ul style="list-style-type: none"> <li>• Check address setting.</li> </ul>
	One of the fixtures is defective and disturbs data transmission on the link.	<ul style="list-style-type: none"> <li>• Bypass one fixture at a time until normal operation is regained: unplug both connectors and connect them directly together.</li> <li>• Have the defective fixture serviced by a qualified technician.</li> </ul>
	3-pin/5-pin XLR Out on the fixtures does not match (pins 2 and 3 reversed).	<ul style="list-style-type: none"> <li>• Install a phase-reversing cable between the fixtures or swap pin 2 and 3 in the fixture, that behaves erratically.</li> </ul>
No light or lamp cuts out intermittently	Fixture is too hot.	<ul style="list-style-type: none"> <li>• Allow fixture to cool.</li> <li>• Turn up the air conditioning .</li> </ul>
	LEDs damaged	<ul style="list-style-type: none"> <li>• Disconnect fixture and return to your dealer.</li> </ul>
	The power supply settings do not match local AC voltage and frequency.	<ul style="list-style-type: none"> <li>• Disconnect fixture. Check settings and correct if necessary.</li> </ul>

## Product Specification

Model:	Showtec NanoQ 12 Q4
Input Voltage:	100-240 VAC, 60/50Hz
Power consumption:	150W
Power linking:	4pcs@110V, 8pcs@240V
DMX linking:	30pcs
Dimensions:	215 x 185 x 290 mm (LxWxH)
Weight:	4,4 kg
<b>Operating and Programming:</b>	
Signal pin OUT:	Pin 1 (earth), pin 2 (-), pin 3 (+)
DMX Mode:	6, 10, 14 channels
Signal input:	3-pin XLR male, 5-pin XLR male
Signal output:	3-pin XLR female, 5-pin XLR female
<b>Electro-mechanical effects:</b>	
LED Quantity:	12 x 4-in-1 10W RGBW LEDs
Backlight:	21 x 3-in-1 RGB LEDs
Light output @ 2 m:	14300 lux
Color mixing:	RGBW
Color range:	16,7 million additive colors
Beam angle:	5-60°
Dimmer: 0-100%	0-100%
Strobe: 0-20Hz	0-20Hz
IP Rating:	IP20
Housing:	Specially designed housing ensures an optimum heat dissipation during operation
DMX-control:	via standard DMX-controller
On Board:	LCD display for easy Set Up
Control:	Auto run, Built-in programs, Manual mode, Sound-controlled, Master/Slave, DMX512
Housing:	Die-cast aluminum powder coat finish
Connections:	Dedicated Pro power connector & Data connector
Cooling:	Convection
Working temperature:	-10°C-40°C
Included:	Schuko to Pro power connector cable (1,5 m)
Max. ambient temperature $t_a$ : 40°C	Max. housing temperature $t_B$ : 80°C
<b>Minimum distance:</b>	
Minimum distance from flammable surfaces:	0,5 m
Minimum distance to lighted object:	1 m

Design and product specifications are subject to change without prior notice.



Website: [www.Showtec.info](http://www.Showtec.info)

Email: [service@highlite.nl](mailto:service@highlite.nl)

## Dimensions

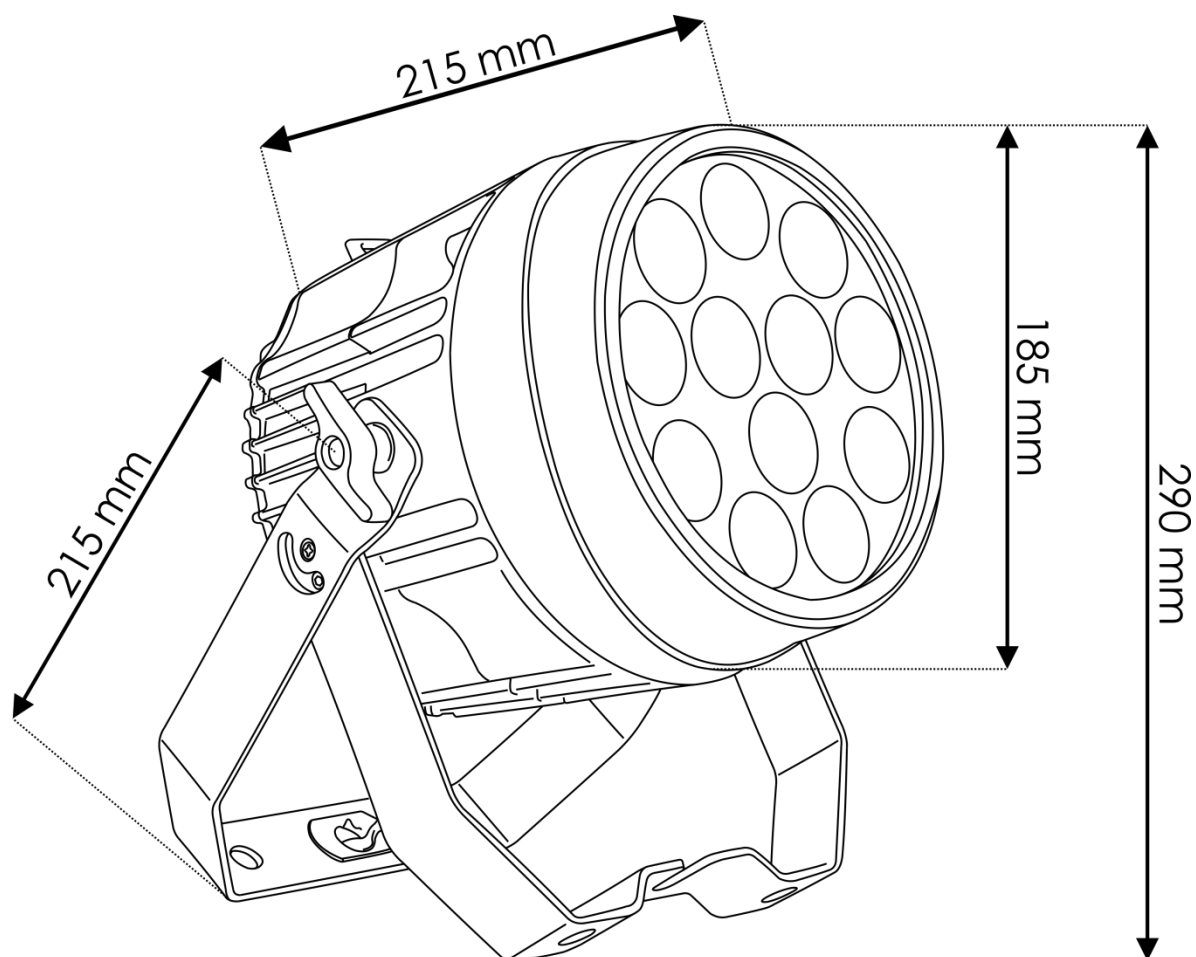







©2015 Showtec