

Cyclone 1320

IP SMD RGBW Strobe/Wash

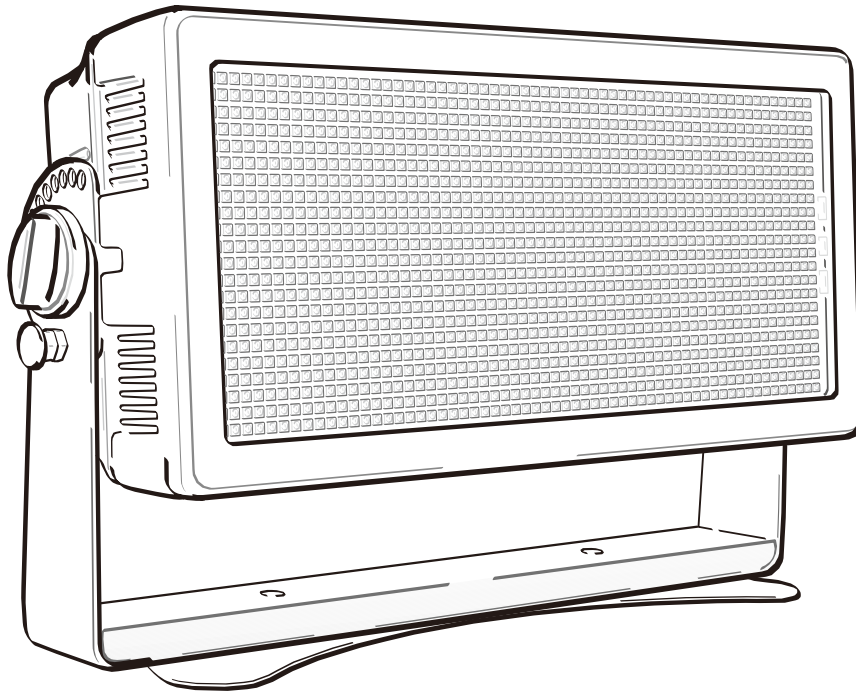

CE

Multiflood Pro IP SMD RGBW Strobe/Wash

Weatherproof (IP65) 3in1 LED effect light with RGBW color mixing



DMX



**STAND
ALONE**



**MASTER
SLAVE**



STROBE



RGBW



IP65

User Manual

USER MANUAL

Cyclone 1320

MULTIFLOOD PRO IP SMD RGBW STROBE/WASH



DANGER! Electric shock caused by short-circuit
Be careful with your operations. With a dangerous voltage you can suffer a dangerous electric shock when touching the wires. Never open the housing.



Please read these instructions carefully before using the product. They contain important information for the correct use of the product.

Every person involved with the installation, operation and maintenance of this device has to

- be qualified
- follow the instructions of this manual
- consider this manual to be part of the total product
- keep this manual for the entire service life of the product
- pass this manual on to every further owner or user of the product
- download the latest version of the user manual from the Internet

INTRODUCTION

Thank you for having chosen one of our products. If you follow the instructions given in this manual, we are sure that you will enjoy this device for a long period of time.

Product features

Weatherproof (IP65) 3in1 LED effect light with RGBW color mixing

- Suitable for external use (IP65)
- effects in one device: strobe, blinder and wash light
- 1320 high-power RGBW LEDs, SMD 5050
- LEDs controllable in 6 segments in DMX mode
- Auto, master/slave and DMX mode
- 36 built-in automatic programs with 16 selectable colors, 2 color effects and variable speeds
- Stepless RGBW color blend, dimmer and strobe effect with variable speed, random strobe effect
- Various dimmer curves adjustable
- Addressing and setting via control panel with LCD screen and four operating buttons
- DMX512 control possible via any commercial DMX controller
- 4, 5, 7, 13, 15 or 31 DMX channels selectable
- Swivel mounting bracket with locking possibility
- Fan cooled
- IP T-Con power input
- Hanging installation via quick-lock Omega holders

SAFETY INSTRUCTIONS



WARNING!

Please read the safety warnings carefully and only use the product as describe in this manual to avoid accidental injury or damage.

Intended use

- This device is an LED spotlight (outdoor) for creating decorative lighting effects. This device is designed for professional use in the field of event technology, e.g. on stage. It is not suitable for household lighting.
- Only use the device according to the instructions given herein. Damages due to failure to follow these operating instructions will void the warranty! We do not assume any liability for any resulting damage.
- We do not assume any liability for material and personal damage caused by improper use or non-compliance with the safety instructions. In such cases, the warranty/guarantee will be null and void.
- Unauthorized rebuilds or modifications of the device are not permitted for reasons of safety and render the warranty invalid.

Danger due to electricity

- This product is designed to light indoor and outdoor areas and is IP65 rated. It can be mounted and operated in indoor and outdoor areas.
- To reduce the risk of electric shock, do not open any part of the device. There are no serviceable parts inside the device.
- Only connect the device to a properly installed mains outlet. The outlet must be protected by residual current breaker (RCD). The voltage and frequency must exactly be the same as stated on the device. If the mains cable is equipped with an earthing contact, then it must be connected to an outlet with a protective ground. Never defeat the protective ground of a mains cable. Failure to do so could result in damage to the device and possibly injure the user.
- For outdoor use make sure to connect a rubber cable H05RN-F or HO5RR-F. For installations in the ground an underground power cable NYY must be used. All valid instructions concerning the installation of cables outdoors or in the ground must be adhered to.
- The mains outlet must be easily accessible so that you can unplug the device quickly if need be.
- Never touch the mains plug with wet or damp hands. There is the risk of potentially fatal electric shock.
- The mains cable must not be bent or squeezed. Keep it away from hot surfaces or sharp edges.
- Never pull the mains cable to disconnect the mains plug from the mains outlet, always seize the plug.
- Unplug the device during lightning storms, when unused for long periods of time or before cleaning.
- Do not expose the device to any high temperatures, direct sunlight, strong vibrations or heavy mechanical stress.
- Do not immerse the product in water, this will destroy it. Furthermore, this could cause a lethal electric shock!
- Only have repairs to the device or its mains cable carried out by qualified service personnel. Repairs are required when the device or the mains cable is visibly damaged, when the device has been dropped or malfunctions occur.

Danger to children and people with restricted abilities

- This product is not a toy. Keep it out of the reach of children and pets. Do not leave packaging material lying around carelessly. Never leave this device running unattended.
- This device may be used only by persons with sufficient physical, sensorial, and intellectual abilities and having corresponding knowledge and experience. Other persons may use this device only if they are supervised or instructed by a person who is responsible for their safety.

Warning – risk of burns and fire

- The admissible ambient temperature range (T_a) is -5 to $+45^\circ\text{C}$. Do not operate the device outside of this temperature range.
- The housing temperature (T_c) can be up to 60°C during use. Avoid contact by persons and materials.
- Do not illuminate surfaces within 20 cm of the device. This value is indicated on the device by the  symbol.
- Do not use the device near highly flammable materials. Always place the device at a location where sufficient air circulation is ensured. Leave 50 cm of free space around the device. Never cover the air vents of the housing.

Warning – risk of injuries

- Do not look directly at the light source. Persons with light-sensitive epilepsy may suffer from epileptic seizures or fall unconscious.
- Make sure that the product is set up or installed safely and expertly and prevented from falling down. Comply with the standards and rules that apply in your country, in particular EN 60598-2-17.
- If you lack the qualification, do not attempt the installation yourself, but instead use a professional installer. Improper installation can result in bodily injury and or damage to property.
- The manufacturer cannot be made liable for damages caused by incorrect installations or insufficient safety precautions.
- For overhead use, always secure the device with a secondary safety attachment such as a safety bond or safety net.
- Make sure that the area below the installation place is blocked when rigging, derigging or servicing the device.
- For commercial use the country-specific accident prevention regulations of the government safety organization for electrical facilities must be complied with at all times.

Caution – material damage

- This device must not be connected to the mains voltage by means of a dimmer.
- Lighting effects are not designed for permanent operation. Consistent operation breaks will ensure that the device will serve you for a long time without defects.
- Never switch the device on and off at short intervals. This will considerably reduce the service life of the device.
- If the device has been exposed to drastic temperature fluctuation, do not switch it on immediately. The resulting condensation may destroy the device. Allow the device to reach room temperature before connecting it. Wait until the condensation has evaporated.
- Please use the original packaging to protect the device against vibration, dust and moisture during transportation or storage.
- If a serial number label is affixed to the device, do not remove the label as this would make the guarantee void.

DESCRIPTION OF THE DEVICE

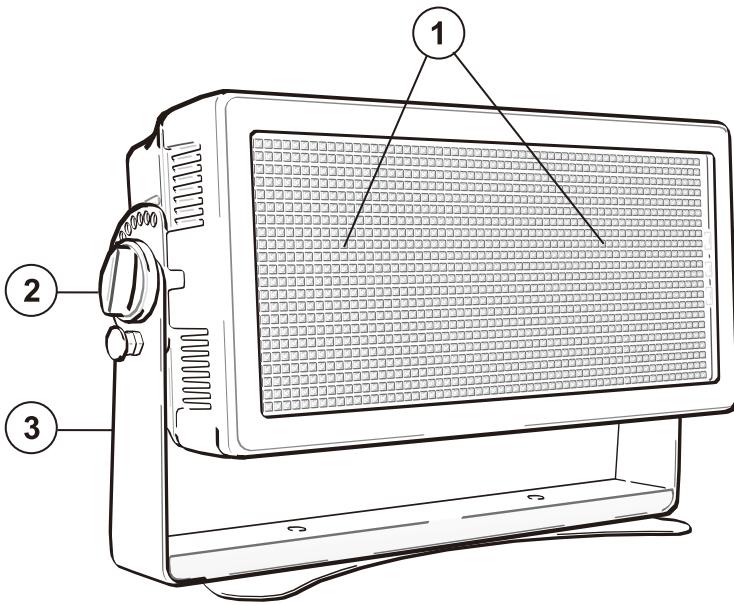

- (1) RGBW-LEDs, SMD 5050
- (2) Fixation screw
- (3) Mounting bracket

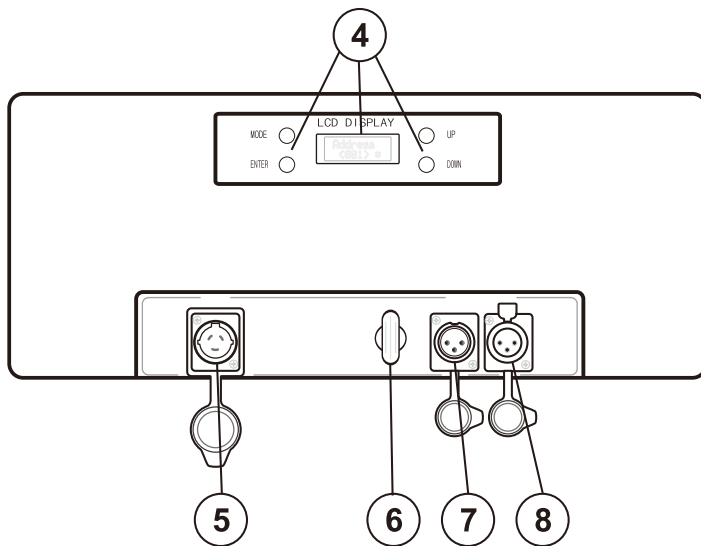

- (4) LCD and operating buttons
- (5) Power input
- (6) Safety rope
- (7) DMX input
- (8) DMX output

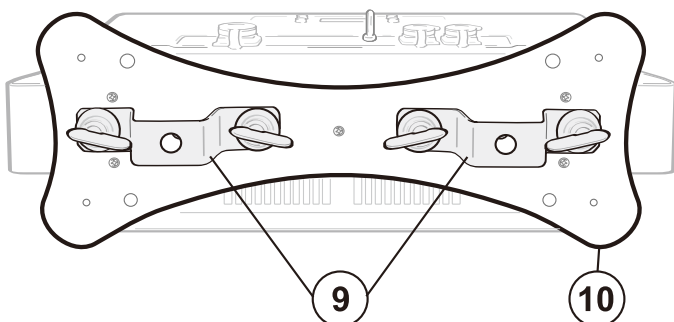

- (9) Omega holders
- (10) Mounting plate

INSTALLATION



WARNING! Risk of injury caused by falling objects

Devices in overhead installations may cause severe injuries when crashing down. Make sure that the device is installed securely and cannot fall down. The installation must be carried out by a specialist who is familiar with the hazards and the relevant regulations.

The device may be fastened to a truss or similar rigging structure. The device must never be fixed swinging freely in the room.

- 1 The rigging structure must support at least 10 times the weight of all fixtures to be installed on it.
- 2 Block access below the work area and work from a stable platform when installing the device.
- 3 Use rigging hardware that is compatible with the structure and capable of bearing the weight of the device. Please refer to the "Accessories" section for a list of suitable rigging hardware.
- 4 Secure the device with a safety bond or other secondary attachment. This secondary safety attachment must be sufficiently dimensioned in accordance with the latest industrial safety regulations and constructed in a way that no part of the installation can fall down if the main attachment fails. An appropriate eyelet is mounted on the device for fixation of the safety rope. Fasten the safety rope in such a way that, in the event of a fall, the maximum drop distance of the device will not exceed 20 cm.
- 5 To align the device, release the fixation screws at the mounting bracket, adjust the desired inclination angle and retighten the fixation screws.
- 6 After installation, the device requires inspections periodically to prevent the possibility of rot, deformation and looseness.

Screw one clamp each via a M10 screw and self-locking nut onto the Omega holders.

Insert the quick-lock fasteners of the first Omega holder into the respective holes on the mounting plate. Tighten the quick-lock fasteners fully clockwise. Install the second Omega holder.

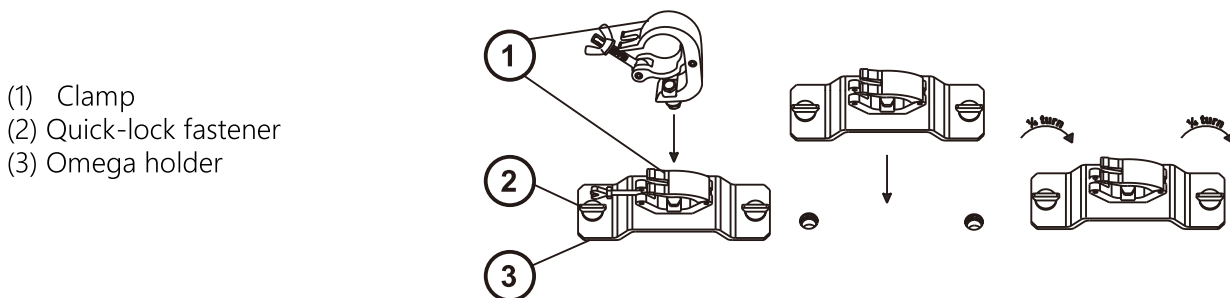

CONNECTIONS

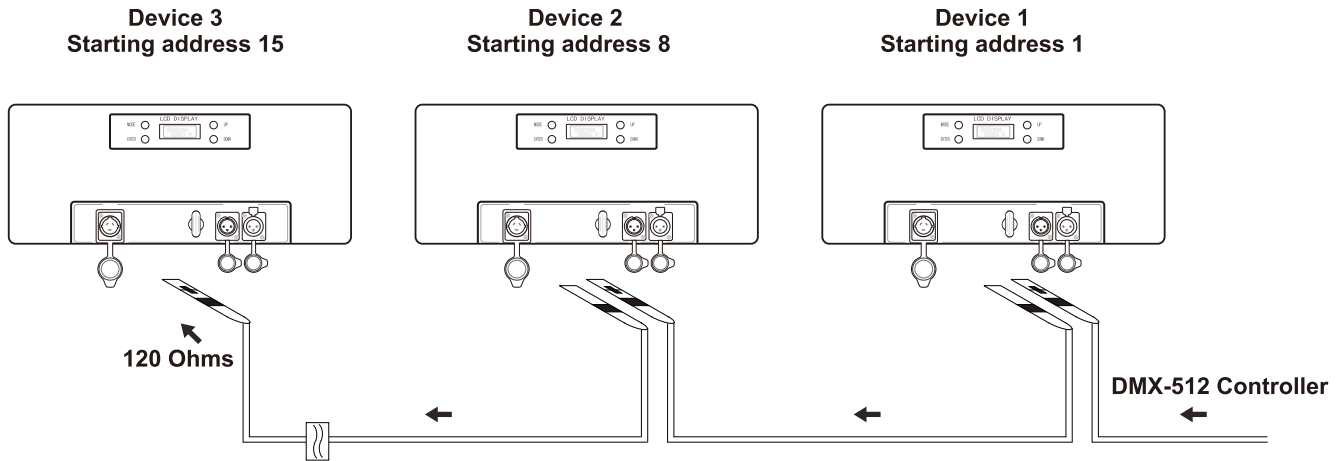

DMX512 control

A DMX512 data link is required in order to control the device via DMX. The device provides 3-pin XLR connectors for DMX connection.

- 1 Connect the output of your DMX controller to the DMX input DMX IN of the light set with a DMX cable.
- 2 Connect the DMX output DMX OUT of the light set to the DMX input of the next unit in the chain. Always connect one output to the input of the next unit until all units are connected.
- 3 At the last unit, the DMX cable has to be terminated. Plug the terminator with a 120 Ω resistor between Signal (-) and Signal (+) in the DMX output of the last unit.
- 4 If the cable length exceeds 300 m or the number of DMX devices is greater than 32, it is recommended to insert a DMX level amplifier to ensure proper data transmission.

XLR connection:



Connection to the mains

The device uses an auto-range power supply that accepts input voltages between 100 und 240 volts.

- 1 The device is equipped with a lockable power input connector. Fix the mains cable and turn it to the right until it locks. Connect the device via the mains cable to a grounded mains socket. Thus the unit is switched on.
- 2 To switch off the unit, disconnect the power plug.
- 3 Do not connect the unit to the mains voltage via a dimmer. For a more convenient operation, use a mains outlet which is switchable.

Please make sure that open contacts are closed with

caps in order to avoid humidity and dirt in the

OPERATION

After connecting the device to the mains it is ready for operation. After switching on, the fans run at full power for a short time. This is an intended cleaning function.

The display indicates the last operating mode. The operating modes can be selected by means of the display and the control buttons. All settings remain stored even if the device is disconnected from the mains. The device can be operated in stand-alone mode via the control board or in DMX-controlled mode via any commercial DMX controller.

Menu structure

Display		Function	
Address		001-512	DMX address setting
Channel		4, 5, 7, 13, 15, 31	Setting DMX channel mode
DMX Monitor	CH:31	Manual setting of DMX values for each DMX Channel	
	CH:15		
	CH:13		
	CH:07		
	CH:05		
	CH:04		
Auto	Auto 00 ~ Auto 36		Program 00 ~ Program 36 (00 = continuously on)
Speed	000 - 255		Program running speed slow > fast
Color	0 - 17		Setting the color/color effects of the Auto program
Effect on Auto	Dimmer	000 - 255	Brightness dark > bright
	Strobe	000 - 255	Strobe-Effect slow > fast
Mas Mode	Yes	Master - Slave	Master/Slave Function on
	No		Master/Slave Function off
Manual	Dimmer	000 - 255	Brightness dark > bright
	Strobe	000 - 255	Strobe-Effect slow > fast
	Red	000 - 255	Intensity 0 – 100 %
	Green	000 - 255	Intensity 0 – 100 %
	Blue	000 - 255	Intensity 0 – 100 %
	White	000 - 255	Intensity 0 – 100 %
Back L (Display shutoff time)	On		Constantly on
	60s		Off after 60 seconds
	120s		Off after 120 seconds
	300s		Off after 300 seconds
Temp	Temp 1	XXC°	Temperature of the LCD panel
	Temp 2	XXC°	Inside temperature
Info	Test 1		
	Test 2		
	Reset	Yes / No	Restore factory settings
	Version		Current software version
Dimmer curve	Curve 0	Linear	Dimmer curves
	Curve 1	Square	
	Curve 2	InvSquare	
	Curve 3	S-curve	
Fade time	Speed 0 ~ Speed 7		Fade fast > slow

Attention! In stand-alone mode, the full light output of the device cannot be called up.

Stand-alone mode

DMX Monitor

Here you can set the DMX values for each channel in the desired DMX channel mode manually.

- 1 Press the MODE button so many times until DMX Monitor is indicated on the display. Confirm with the ENTER button.
- 2 Use the buttons UP and DOWN to select the desired DMX channel mode and confirm with the ENTER button.
- 3 You can now set the desired DMX value for each channel in the chosen DMX mode. Confirm with the ENTER button.

Automatic mode

In automatic mode, various show programs are available that run at an adjustable speed. Additionally, a desired color can be set.

- 1 Press the MODE button so many times until Auto is indicated in the display. Confirm with the ENTER button. Use the buttons UP and DOWN to select the desired show program. Confirm with the ENTER button. (Program 00 is a single color steady on).
- 2 The display now indicates Speed. Confirm with the ENTER button. Use the buttons UP and DOWN to adjust the running speed of the program from 000 (slow) to 255 (fast). Confirm with the ENTER button.
- 3 Now the display now indicates Color. Confirm with the ENTER button. Use the buttons UP and DOWN to set the desired program color from 0 to 18. Confirm with the ENTER button.

With the MODE button you can return to the main menu.

Effect on Auto

In this mode, you can set the desired brightness and strobe speed of the programs in Automatic Mode.

- 1 Press the MODE button so many times until Effect on Auto is indicated in the display. Confirm with the ENTER button.
- 2 The display shows Dimmer. Confirm with the ENTER button
- 3 Use the buttons UP and DOWN to select the desired brightness, from 000 (dark) to 255 (bright). Confirm with the ENTER button.
- 4 The display now indicates Strobe. Confirm with the ENTER button.
- 5 Use the buttons UP and DOWN to adjust the strobe speed from 000 (slow) to 255 (fast). Confirm with the ENTER button.

With the MODE button you can return to the main menu.

Mas Mode

In this mode, you can set the Master and Slave devices.

Several devices may be interconnected (max. 32). Then all slave units can be synchronized and controlled with the master unit without the need for a DMX controller. The devices must be set to the corresponding operating modes.

Configure all slave units before connecting the master unit.

- 1 Connect the DMX output of the master unit to the DMX input of the first slave unit. Then connect the DMX output of the first slave unit to the DMX input of the second slave unit, etc. until all units have been connected in a chain. Make sure the master unit is the first in the chain. Do not connect a DMX controller to the DMX input of the master unit.
- 2 Press the MODE button so many times until Mas Mode is indicated in the display. Confirm with the ENTER button.

- 3 Use the buttons UP and DOWN to select the desired setting, yes or no for Master or Slave, depending upon the device. Confirm with the ENTER button.
- 4 Set the master unit to the desired operating mode. The interconnected devices will now operate synchronously.

With the MODE button you can return to the main menu.

Manual

In this mode, you can manually set the desired brightness and strobe speed, as well as the intensity of the colors Red, Green, Blue and White.

- 1 Press the MODE button so many times until Manual is indicated in the display. Confirm with the ENTER button.
- 2 The display shows Dimmer. Confirm with the ENTER button
- 3 Use the buttons UP and DOWN to select the desired brightness, from 000 (dark) to 255 (bright). Confirm with the ENTER button.
- 4 The display now indicates Strobe. Confirm with the ENTER button.
- 5 Use the buttons UP and DOWN to adjust the strobe speed from 000 (slow) to 255 (fast). Confirm with the ENTER button.
- 6 The display then shows Red. Confirm with the ENTER button
- 7 Use the buttons UP and DOWN to select the desired intensity, from 000 (dark) to 255 (bright). Confirm with the ENTER button.
- 8 Continue this procedure to set the desired intensity for the colors green, blue and white.

With the MODE button you can return to the main menu.

Back L

With this function, you can adjust the display characteristics when the buttons are inactive:

- 1 Press the MODE button so many times until Back L is indicated in the display. Confirm with the ENTER button.
- 2 Use the buttons UP and DOWN to select the desired setting and confirm with the ENTER button.

On – Display always on

60s - Shuts off the display after 60 seconds

120s - Shuts off the display after 120 seconds

300s - Shuts off the display after 300 seconds

With the MODE button you can return to the main menu.

Temp

With this function, device temperatures can be displayed.

- 1 Press the MODE button so many times until Temp is indicated in the display. Confirm with the ENTER button.
- 2 Use the buttons UP and DOWN to select the desired temperature reading and confirm with the ENTER button.

Temp 1: Displays the LCD temperature.

Temp 2: Displays the inner temperature of the device.

With the MODE button you can return to the main menu.

Info

In this mode, several settings can be read out or set.

- 1 Press the **MODE** button so many times until Info is indicated in the display. Confirm with the **ENTER** button.
- 2 Use the buttons **UP** and **DOWN** to select the desired setting and confirm with the **ENTER** button. The desired setting will be executed.

Test 1: The device conducts a test.

Test 2: The device conducts a test.

Reset: With this function, you can reset the device via the Control Board (yes/no).

Version: With this function, you can display the software version of the device.

With the **MODE** button you can return to the main menu.

Dimmer curve

With this function, you can set various dimmer curves.

- 1 Press the **MODE** button so many times until Dimmer curve is indicated in the display. Confirm with the **ENTER** button.
- 2 Use the buttons **UP** and **DOWN** to select the desired Dimmer curve and confirm with the **ENTER** button.

Curve 0 - **LINEAR**: The brightness increases linearly with the DMX value.

Curve 1 - **SQUARE LAW**: The brightness increases exponentially with the DMX value.

Curve 2 - **INVERSE SQUARE LAW**: The brightness increases reverse exponentially with the DMX value.

Curve 3 - **S-CURVE**: The brightness increases S-shaped with the DMX value.

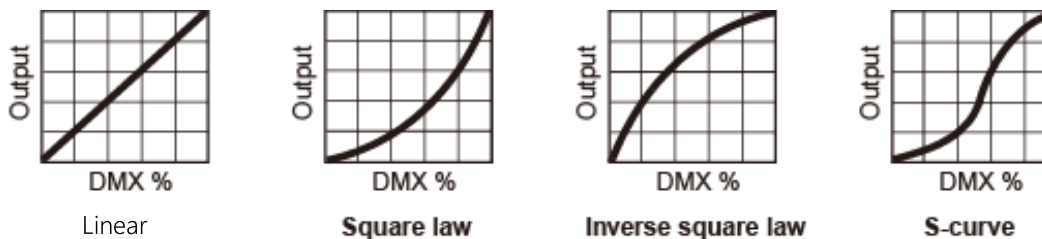

With the **MODE** button you can return to the main menu.

Fade time

With this function, you can set the fade time.

- 1 Press the **MODE** button so many times until Fade time is indicated in the display. Confirm with the **ENTER** button.
- 2 Use the buttons **UP** and **DOWN** to select the desired fade time 00 (fast) to 07 (slow) and confirm with the **ENTER** button.

With the **MODE** button you can return to the main menu.

DMX operation

Setting the number of DMX channels and the DMX starting address

For operation with a controller with DMX512 protocol, the device is equipped with 31 control channels. However, it can also be switched to a mode with 4, 5, 7, 13, or 15 channels if different functions are required. To be able to operate the device with a DMX controller, the DMX starting address must be set. The starting address depends upon which DMX controller is being used. Please refer to the controller's documentation.

- 1 Press the MODE button so many times until Address is indicated on the display. Confirm with the ENTER button.
- 2 Set the address via the UP and DOWN buttons and press the MODE button to return to the main menu.
- 3 Now press the MODE button so many times until Channel is indicated on the display.
- 4 The display indicates 4 CH (4 DMX channels), 5 CH (5 DMX channels), 7 CH (7 DMX channels), 13 CH (13 DMX channels), 15 CH (15 DMX channels) or 31 CH (31 DMX channels). Use the buttons UP and DOWN to select the desired number of DMX channels. Confirm with the ENTER button.
- 4 If no control signals are available, a * will blink on the display. The * will not blink when DMX signals are being received

Note: Please make sure that you do not have any overlapping channels in order to control each device correctly and independently from any other fixture on the DMX chain. If several devices are addressed similarly, they will work synchronically.

The LEDs of the device are divided into different segment groups with 6 segments each, which can be individually controlled with the following DMX protocol.

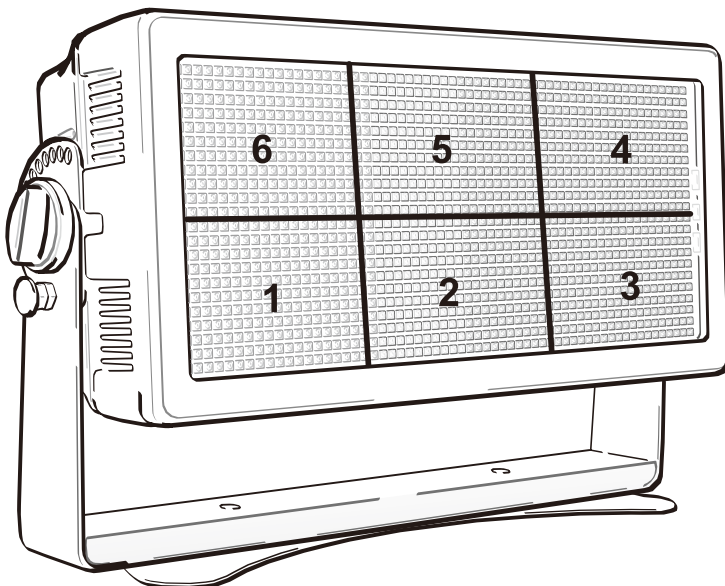

Functions in DMX mode

4-channel mode

Channel	Value	Function
1	000 – 255	Red 0-100%
2	000 – 255	Green 0-100%
3	000 – 255	Blue 0-100%
4	000 – 255	White 0-100%

5-channel mode

Channel	Value	Function
1	000 – 005	No function
	006 – 250	Strobe with increasing speed 0-100%
	251 – 254	RGBW on
	255 – 255	Special strobe, RGBW full on
2	000 – 005	No function
	006 – 250	Strobe with increasing speed 0-100%
	251 – 255	Red 100%
3	000 – 005	No function
	006 – 250	Strobe with increasing speed 0-100%
	251 – 255	Green 100%
4	000 – 005	No function
	006 – 250	Strobe with increasing speed 0-100%
	251 – 255	Blue 100%
5	000 – 005	No function
	006 – 250	Strobe with increasing speed 0-100%
	251 – 255	White 100%

7-channel mode

Channel	Value	Function
1	000 – 255	RGBW with increasing brightness 0-100%
2	000 – 000	No function
	001 – 255	Strobe intensity from short to long
3	000 – 004	No function
	005 – 255	Strobe with increasing speed 0-100%
4	000 – 000	No function
	001 – 255	Random strobe
5	000 – 009	No function
	010 – 255	Internal programs
6	000 – 255	Increasing speed (0-100%) of the internal programs
7	000 – 255	Color presets *

* = See graphic at the end of the DMX protocol

13-channel mode

Channel	Value	Function
1	000 – 255	Master Dimmer
2	000 – 255	Red 0-100%
3	000 – 255	Green 0-100%
4	000 – 255	Blue 0-100%
5	000 – 255	White 0-100%
6	000 – 005	No function
	006 – 255	Strobe with increasing speed 0-100%
7	000 – 009	No function
	010 – 255	Internal programs
8	000 – 000	No function
	001 – 255	Increasing speed (0-100%) of the internal programs
9	000 – 009	No function
	010 – 255	Color presets *
10	000 – 255	Red background 0-100%
11	000 – 255	Green background 0-100%
12	000 – 255	Blue background 0-100%
13	000 – 255	White background 0-100%

15-channel mode

Channel	Value	Function
1	000 – 255	Master Dimmer
2	000 – 255	Red 0-100%
3	000 – 255	Green 0-100%
4	000 – 255	Blue 0-100%
5	000 – 255	White 0-100%
6	000 – 000	No function
	001 – 255	Strobe intensity from short to long
7	000 – 004	No function
	005 – 255	Strobe with increasing speed 0-100%
8	000 – 000	No function
	001 – 255	Random strobe
9	000 – 009	No function
	010 – 255	Internal programs
10	000 – 255	Increasing speed (0-100%) of the internal programs
11	000 – 009	No function
	010 – 255	Color presets *
12	001 – 255	Red background 0-100%
13	001 – 255	Green background 0-100%
14	001 – 255	Blue background 0-100%
15	001 – 255	White background 0-100%

31-channel mode

Channel	Value	Function
1	000 – 255	Master Dimmer
2	000 – 255	Red 0-100%
3	000 – 255	Green 0-100%
4	000 – 255	Blue 0-100%
5	000 – 255	White 0-100%
LED Group 1		
6	000 – 255	Red 0-100%
7	000 – 255	Green 0-100%
8	000 – 255	Blue 0-100%
9	000 – 255	White 0-100%
LED Group 2		
10	000 – 255	Red 0-100%
11	000 – 255	Green 0-100%
12	000 – 255	Blue 0-100%
13	000 – 255	White 0-100%
LED Group 3		
14	000 – 255	Red 0-100%
15	000 – 255	Green 0-100%
16	000 – 255	Blue 0-100%
17	000 – 255	White 0-100%
LED Group 4		
18	000 – 255	Red 0-100%
19	000 – 255	Green 0-100%
20	000 – 255	Blue 0-100%
21	000 – 255	White 0-100%
LED Group 5		
22	000 – 255	Red 0-100%
23	000 – 255	Green 0-100%
24	000 – 255	Blue 0-100%
25	000 – 255	White 0-100%
LED Group 6		
26	000 – 000	No function
	001 – 255	Strobe intensity from short to long
27	000 – 004	No function
	005 – 255	Strobe with increasing speed 0-100%
28	000 – 000	No function
	001 – 255	Random strobe
29	000 – 009	No function
	010 – 255	Internal programs
30	000 – 255	Increasing speed (0-100%) of the internal programs
31	000 – 009	No function
	010 – 255	Color presets *

Color presets in channels 7, 13, 15, 31

000 – 009	No function
010 – 017	Red
018 – 025	Green
026 – 033	Blue
034 – 041	White
042 – 049	Yellow (Red + Green)
050 – 057	Magenta (Red + Blue)
058 – 065	Light Red (Red + White)
066 – 073	Cyan (Blue + Green)
074 – 081	Light Green (White + Green)
082 – 089	Light Blue (White + Blue)
090 – 097	Orange
098 – 105	Red + Green + Blue + White
106 – 113	Red + Green + Blue
114 – 121	Red + Green + White
122 – 128	Gradual color change
129 – 160	Auto program 1
161 – 192	Auto program 2
193 – 224	Increasing speed (0-100%) program 1
225 – 255	Increasing speed (0-100%) program 2



CLEANING AND MAINTENANCE

The outside of the device should be cleaned periodically to remove contaminants such as dust etc. The lenses, in particular, should be clean to ensure that light will be emitted at maximum brightness.

- 1 Disconnect the device from power and allow it to cool before cleaning.
- 2 Clean the surface with a soft lint-free and moistened cloth. Never use alcohol or solvents as these may damage the surface. Make sure that no liquids can enter the device.
- 3 The device must be dry before reapplying power.

There are no serviceable parts inside. Do not open the housing. Do not try to repair the device by yourself as this may result in damage. Maintenance and service operations are only to be carried out by authorized dealers. Should you need any spare parts, please use genuine parts. Should you have further questions, please contact your dealer.

PROTECTING THE ENVIRONMENT

	Disposal of old equipment When to be definitively put out of operation, take the product to a local recycling plant for a disposal which is not harmful to the environment. Devices marked with this symbol must not be disposed of as household waste. Contact your retailer or local authorities for more information.
	Remove any inserted batteries and dispose of them separately from the product.
	You as the end user are required by law (Battery Ordinance) to return all used batteries/rechargeable batteries. Disposing of them in the household waste is prohibited. You may return your used batteries free of charge to collection points in your municipality and anywhere where batteries/rechargeable batteries are sold. By disposing of used devices and batteries correctly, you contribute to the protection of the environment

TECHNICAL SPECIFICATIONS

Power supply:	100-240 V AC, 50/60 Hz
Power consumption:	315 W
Protection class:	I
Protection grade:	IP65
DMX control channels:	4/5/7/13/15/31
DMX512 connection:	3-pin XLR
LED type:	0.4 W RGBW (SMD 5050)
LED number:	1320
Flash rate:	20 Hz
Beam angle:	120°
Dimensions (L x W x H):	160 x 490 x 285 mm
Weight:	12.5 kg

